



One Size Does Not Fit All: Multi-Scale, Cascaded RNNs for Radar Classification

Dhrubojoyoti Roy¹, Sangeeta Srivastava¹, Aditya Kusupati^{2,5}, Pranshu Jain³, Manik Varma^{2,3}, Anish Arora^{1,4}

¹The Ohio State University, ²Microsoft Research India, ³Indian Institute of Technology Delhi, ⁴The Samraksh Company, ⁵University of Washington

1. IoT Requirements in The Smart City

▶ Resource efficiency

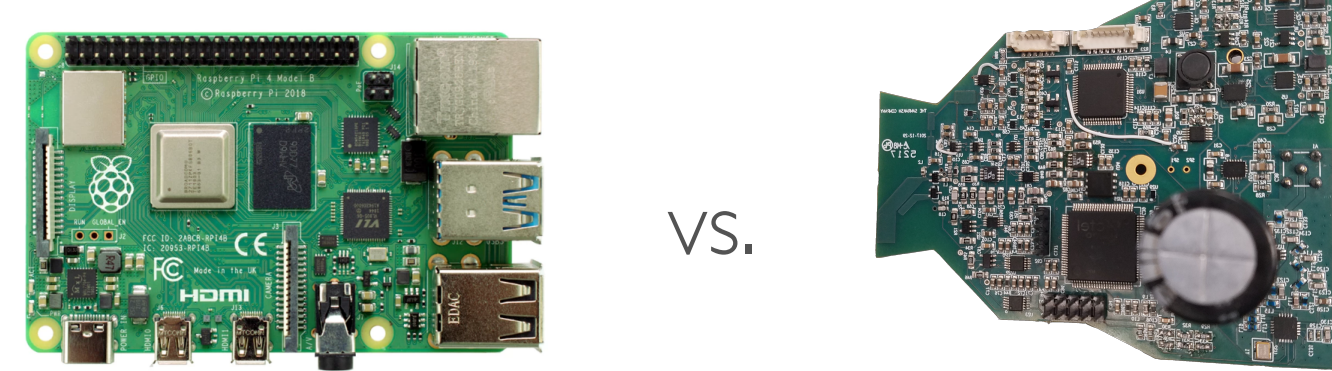

▶ Deployment feasibility

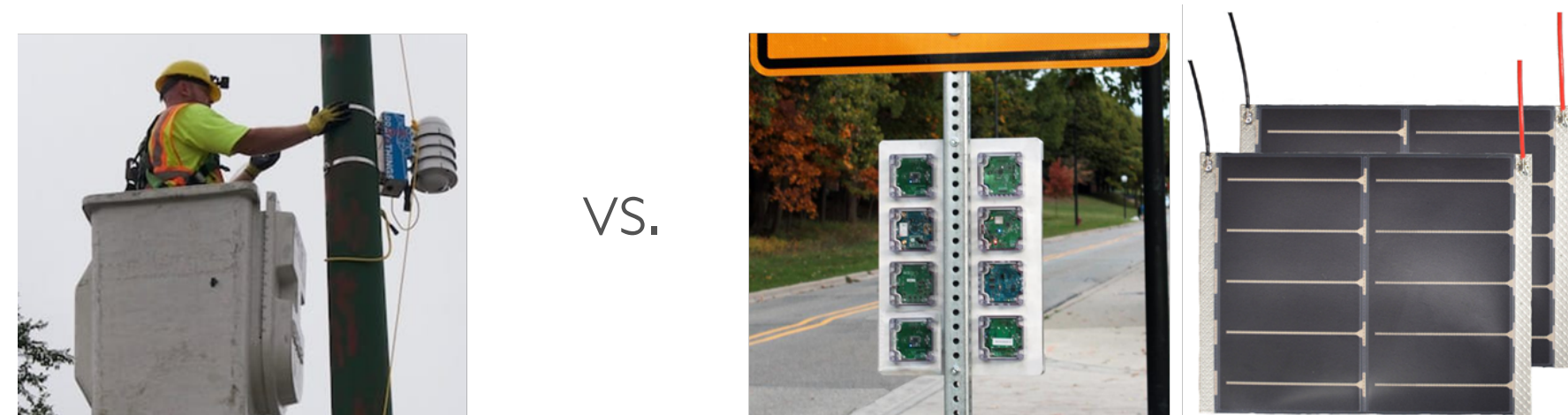

▶ Privacy preserving

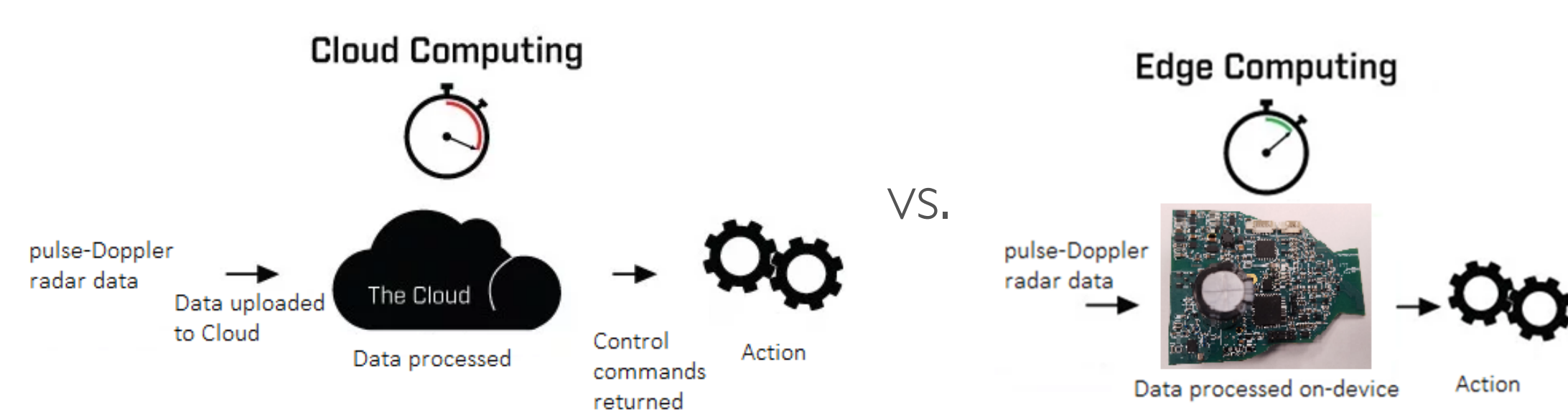

3. MSC-RNN Solution for N+I classes

▶ Multi-Scale Cascaded RNN (MSC-RNN) handles the two sub-problems of clutter rejection and source discrimination at different time scales of featurization

▶ MSC-RNN Components:

- (i) EMI-FastGRNN: works at instance-level and is continuously active
- (ii) FastGRNN: works at window-level

Both the components are cascaded so that FastGRNN is invoked only when EMI-FastGRNN detects displacement source

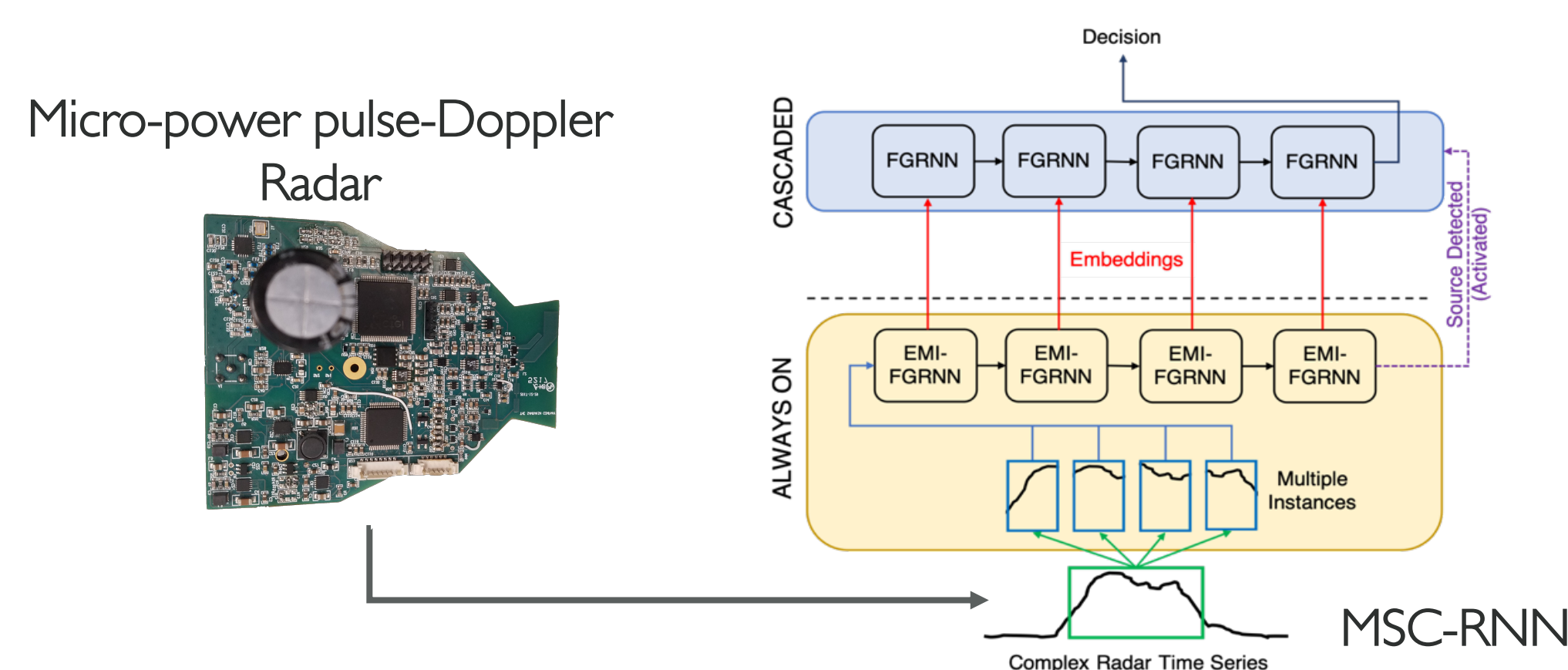

▶ Fast(G)RNN

- FastRNN stabilizes training with residual connections and adds just 2 additional scalars, α & β

- α & β when converted to vector gates result in FastGRNN

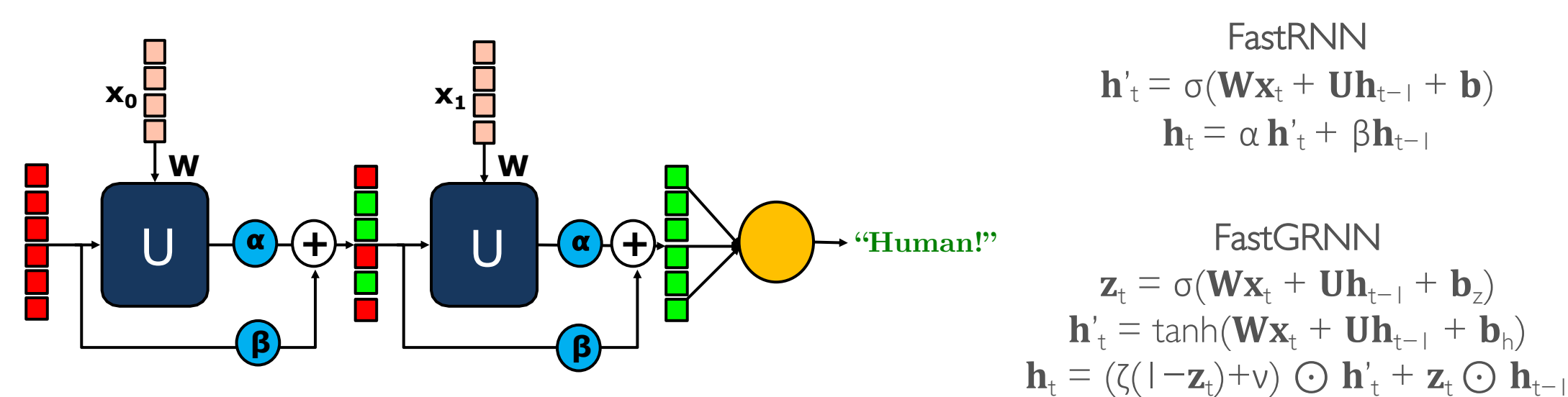

▶ MSC-RNN Training: MSC-RNN training loss emulates cascading behavior

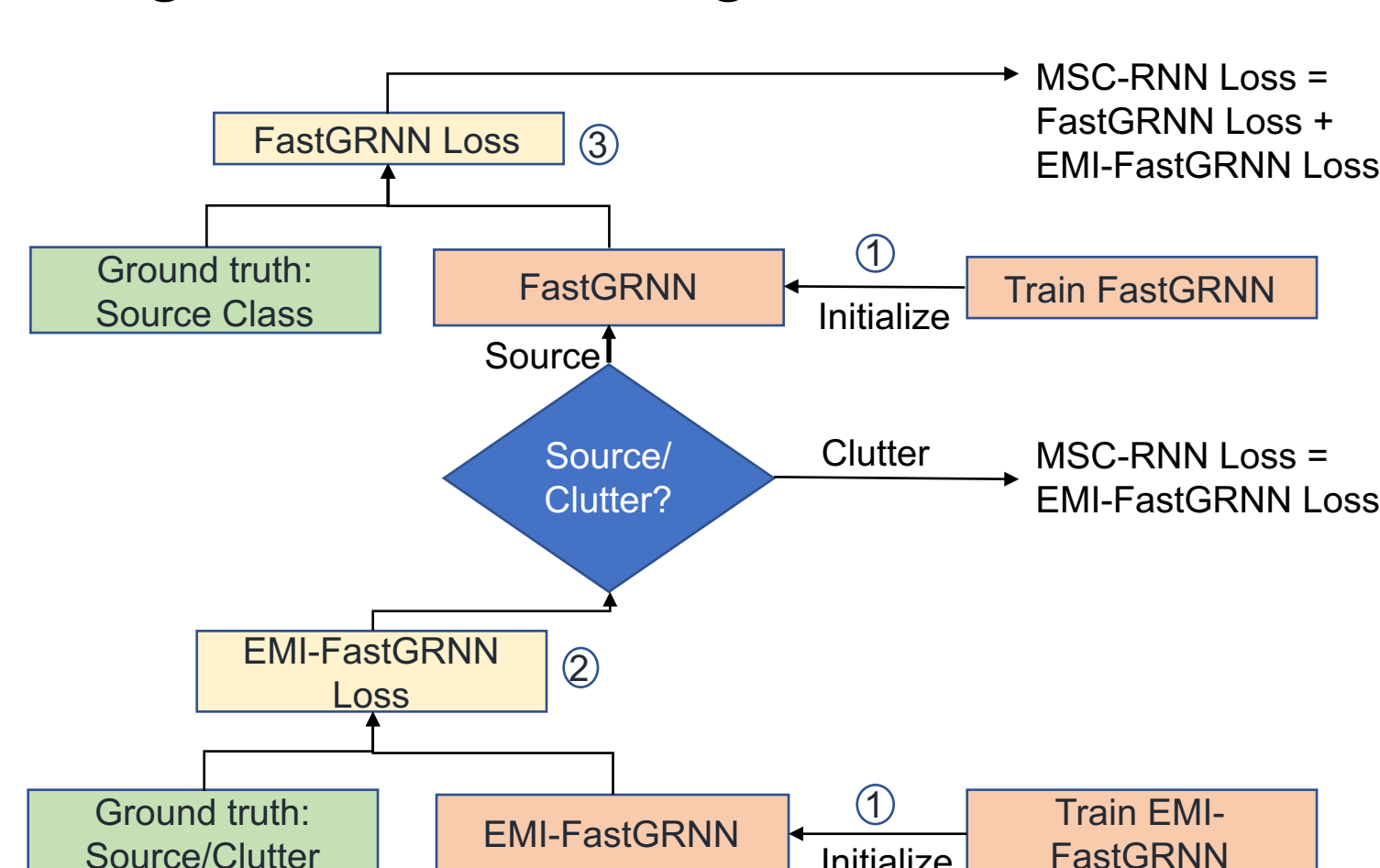

2. N+I-class Radar Classification

▶ Example of N source classes + clutter class (N+I-class) classification

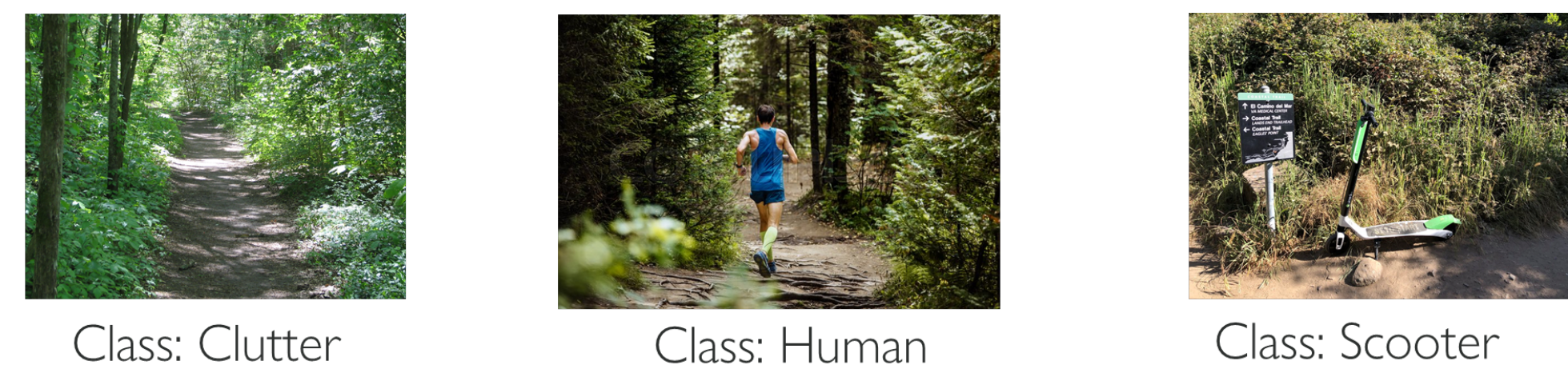

▶ Efficiency-Accuracy trade-off in existing solutions

ML Model	Accuracy	FLOPS	Fits on Cortex-M3?
SVM (15 features)	0.85	37K	Yes
LSTM	0.89	100K	No
CNN (1s FFT)	0.91	1.3M	No
EMI-LSTM	0.90	20K	No
EMI-FastGRNN	0.88	8K	Yes

▶ Interesting events may occur rarely



4. Performance of MSC-RNN

▶ Performance comparison with SVM: Outperforms all-domain feature handcrafting at mote scale with purely time-domain feature learning

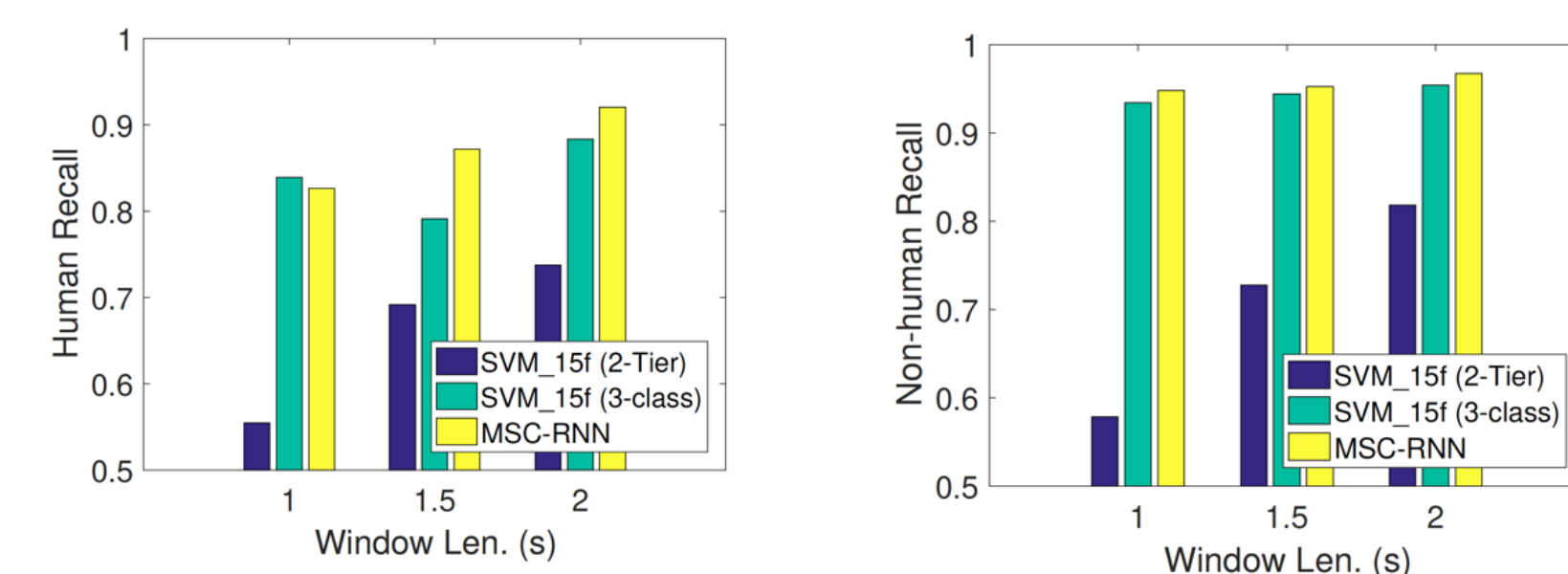

Win. Len. (s)	Accuracy		Clutter Recall	
	SVM_15f (3-class)	MSC-RNN	SVM_15f (3-class)	MSC-RNN
1	0.851	0.944	0.758	0.999
1.5	0.934	0.954	0.996	0.999
2	0.959	0.972	0.999	1.000

▶ Feature computation comparison with SVM: 3.5x more efficient than a competitive SVM solution

Architecture	Est. Duty Cycle (Cortex-M3)	
	97% Clutter	98% Clutter
MSC-RNN (Inp. dim.=2)	21.00%	20.00%
MSC-RNN (Inp. dim.=16)	10.87%	10.70%
2-Tier SVM	2.05%	1.70%
3-Class SVM	35.00%	35.00%

▶ Comparison with EMI: Outperforms monolithic EMI algorithms on all three metrics of accuracy, non-human and human recalls

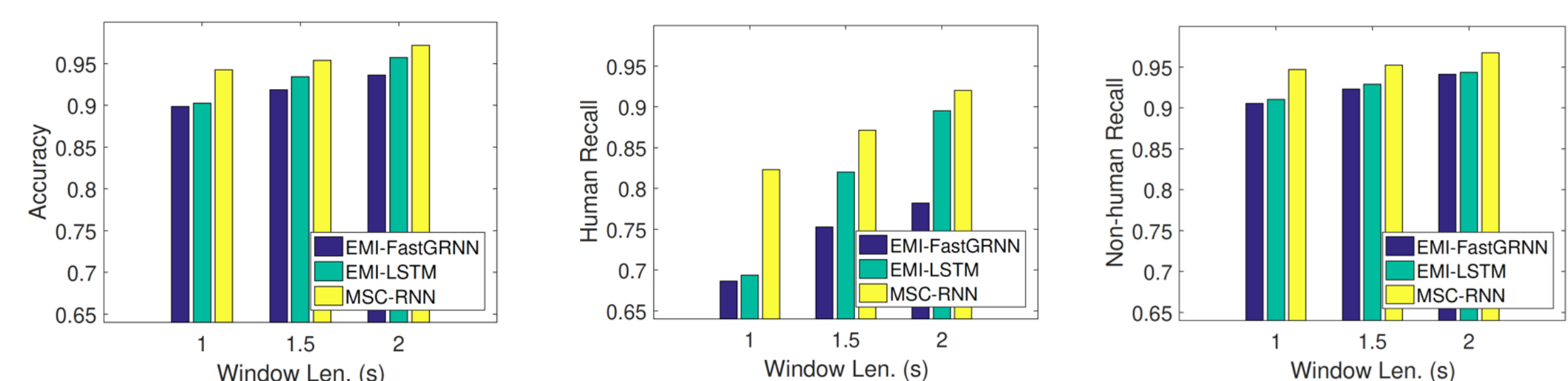

5. References

- [1] Roy, Dhrubojoyoti, et al. One size does not fit all: Multi-scale, cascaded RNNs for radar classification. In ACM BuildSys 2019
- [2] Kusupati, Aditya, et al. Fastgrnn: A fast, accurate, stable and tiny kilobyte sized gated recurrent neural network. In NeurIPS 2018
- [3] Dennis, Don, et al. Multiple instance learning for efficient sequential data classification on resource-constrained devices. In NeurIPS 2018

